

Ópera serie

in&out&in

acabados. finishes



C-1
C-3



R9
R12



Clase C
C class



Ala < 0,5%
Alb < 1,5%
Bla < 0,5%*



V3



rectificado
rectified



exagres
TECHNICAL SOLUTIONS



Ivory



Light



Silver



Iron

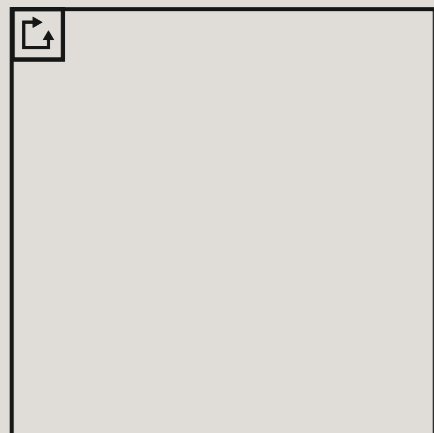

120x120 cm*
47.2" x 47.2"

✂ 10 mm

📏 C-1 📏 R9

📏 C-3 📏 R12 📏 C Class

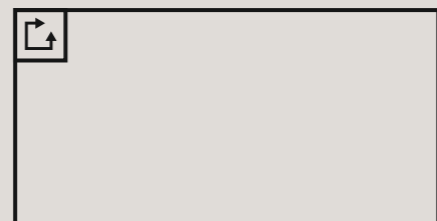

60x120 cm*
23.6" x 47.2"

✂ 9 mm

📏 C-1 📏 R9

📏 C-3 📏 R12 📏 C Class



14,5x120 cm*
5.7" x 47.2"

✂ 9 mm

📏 C-1 📏 R9

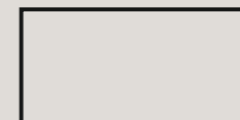

33x66,5 cm
13.0" x 26.2"

✂ 10 mm

📏 C-1 📏 R9

📏 C-3 📏 R12 📏 C Class

Ópera serie

piezas piscina. pool pieces / peldaños y rodapiés. steps&skirtings

exagres
TECHNICAL SOLUTIONS

piezas piscina. pool pieces

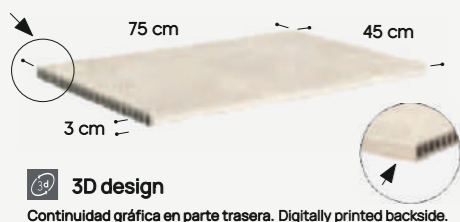

Borde skimmer
45 x 75 x 3 cm
17.7" x 29.5" x 1.2"

rectificado. rectified
C-3 R12 C

3D design

Continuidad gráfica en parte trasera. Digitally printed backside.

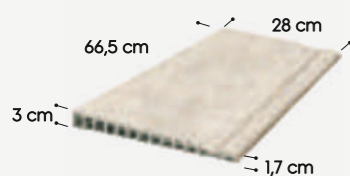

Borde desbordante
28 x 66,5 cm
11.0" x 26.2"

rectificado. rectified
C-3 R12 C

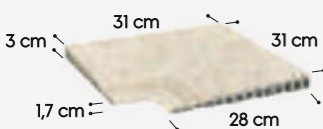

Ángulo desbordante
31 x 31 cm
12.2" x 12.2"

rectificado. rectified
C-3 R12 C

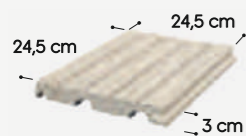

Rejilla
24,5 x 24,5 cm
9.6" x 9.6"

rectificado. rectified
C-3 R12 C

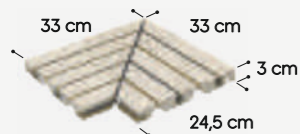

**Ángulo rejilla
izda./dcha.**
33 x 33 cm
13.0" x 13.0"

rectificado. rectified
C-3 R12 C



Media caña 4
4,2 x 33 cm
1.7" x 13.0"



Arista 3
3,3 x 33 cm
1.3" x 13.0"

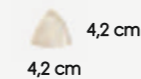

Uña media caña 4
4,2 x 4,2 cm
1.7" x 1.7"

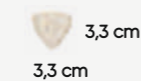

Uña arista 3
3,3 x 3,3 cm
1.3" x 1.3"

peldaños y rodapiés. steps&skirtings

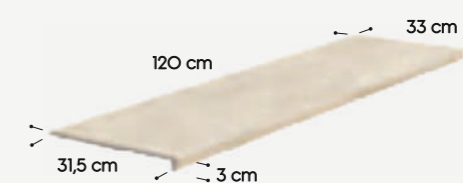

Peldaño recto 120
33 x 120 x 3 cm
13.0" x 47.2" x 1.2"

12 mm

rectificado. rectified
C-1 R9
C-3 R12 C



**Remate peldaño
recto**
3 x 33 cm
1.2" x 13.0"

7,5 mm

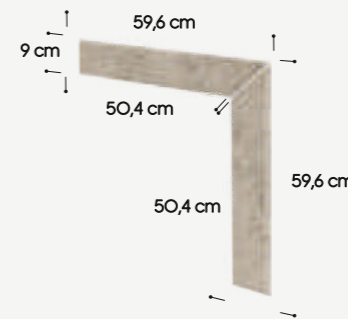

**Zanquín ingletado
recto***
59,6 x 59,6 cm
23.5" x 23.5"

11 mm

*sólo color Light . only Light color

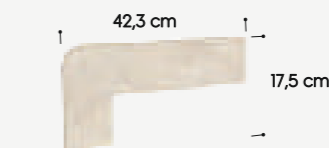

**Zanquín recto
izda./dcha.***
17,5 x 42,3 cm
6.9" x 16.7"

7,5 mm

*Colores Ivory, Silver, Iron. Ivory, Silver, Iron colors



Rodapié
9 x 60 cm
3.5" x 23.6"

11 mm

Ópera



C-1
C-3



R9
R12



Clase C
C class



Ala < 0,5%
Alb < 1,5%
Bla < 0,5%*



V3



rectificado
rectified



exagres
TECHNICAL SOLUTIONS



Ivory

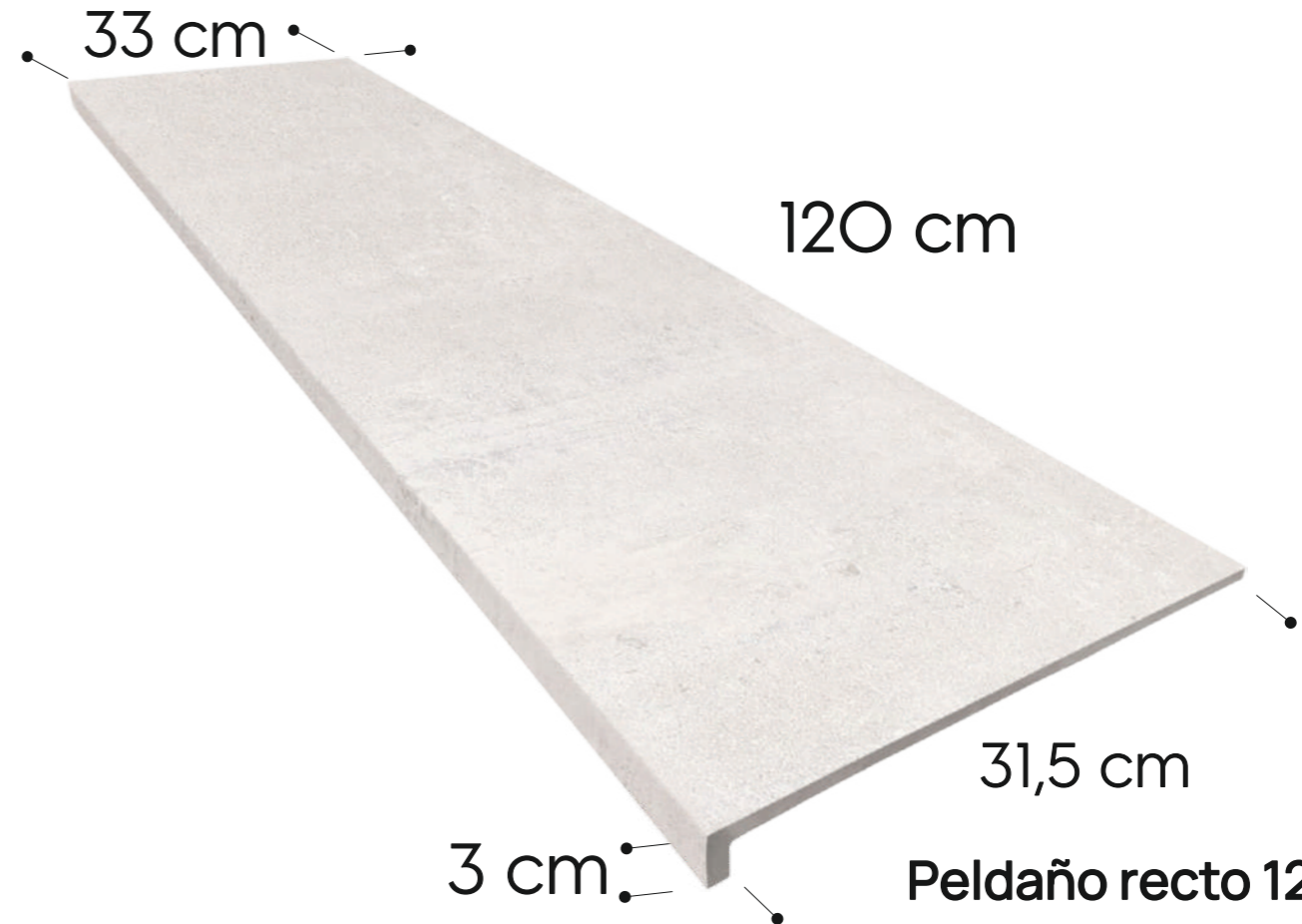

31,5 cm

Peldaño recto 120

33 x 120 x 3 cm

13.0" x 47.2" x 1.2"

✕ 12 mm

 rectificado. rectified

 C-1  R9

 C-3  R12  C

Ópera



C-1
C-3



R9
R12



Clase C
C class



Ala < 0,5%
Alb < 1,5%
Bla < 0,5%*



V3



rectificado
rectified



exagres
TECHNICAL SOLUTIONS



Peldaño recto 120

33 x 120 x 3 cm

13.0" x 47.2" x 1.2"

✕ 12 mm

 rectificado. rectified

 C-1  R9

 C-3  R12  C

Light

Ópera



C-1
C-3



R9
R12



Clase C
C class



Ala < 0,5%
Alb < 1,5%
Bla < 0,5%*



V3



rectificado
rectified



exagres
TECHNICAL SOLUTIONS



31,5 cm

Peldaño recto 120

33 x 120 x 3 cm

13.0" x 47.2" x 1.2"

✕ 12 mm

 rectificado. rectified

 C-1  R9

 C-3  R12  C

Silver

Ópera



C-1
C-3



R9
R12



Clase C
C class



Ala < 0,5%
Alb < 1,5%
Bla < 0,5%*



V3



rectificado
rectified



exagres
TECHNICAL SOLUTIONS



Iron

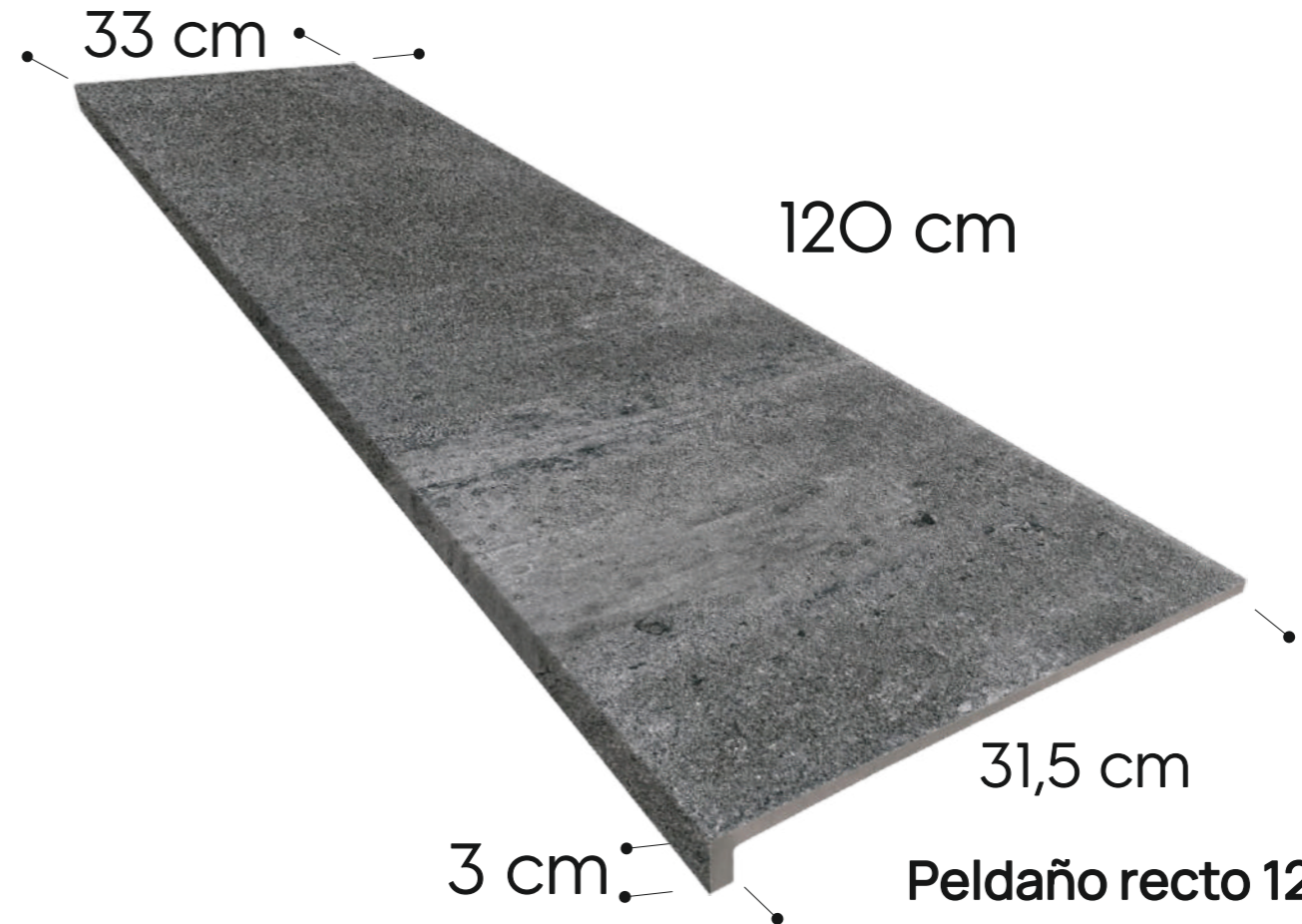

31,5 cm

Peldaño recto 120

33 x 120 x 3 cm

13.0" x 47.2" x 1.2"

✕ 12 mm

 rectificado. rectified

 C-1  R9

 C-3  R12  C



URBAN
Ópera
in&out&in



ESPAÑOL / ENGLISH

URBAN

Ópera indoor



ivory]

1 Base - 120x120 cm - C-1 / R9

2 Peldaño recto 120 · 33x120x3 cm - C-1 / R9

3 Tabica · 14,5x120 cm - C-1 / R9



URBAN

Ópera indoor



light]

- 1 Base - 120x120 cm - C-1 / R9
- 2 Peldaño recto 120 - 33x120x3 cm - C-1 / R9
- 3 Tabica - 14,5x120 cm - C-1 / R9

iron]

- 1 Base - 60x120 cm - C-1 / R9
- 2 Base yoho oak - 25x150 cm - C-1 / R9



URBAN

Ópera outdoor+overflow pool coping



iron

1 Base · 120x120 cm - C-3 / R12+C
2 Base · 33x66,5 cm - C-1 / R9

3 Borde desbordante · 28x66,5 cm - C-3 / R12+C
4 Rejilla · 24,5x24,5 cm - C-3 / R12+C

5 Áng. rejilla · 33x33 cm - C-3 / R12+C
6 Áng. desbordante · 31x31 cm - C-3 / R12+C

7 Peldaño recto 120 · 33x120x3 cm - C-3 / R12+C
8 Tabica · 14,5x120 cm - C-1 / R9

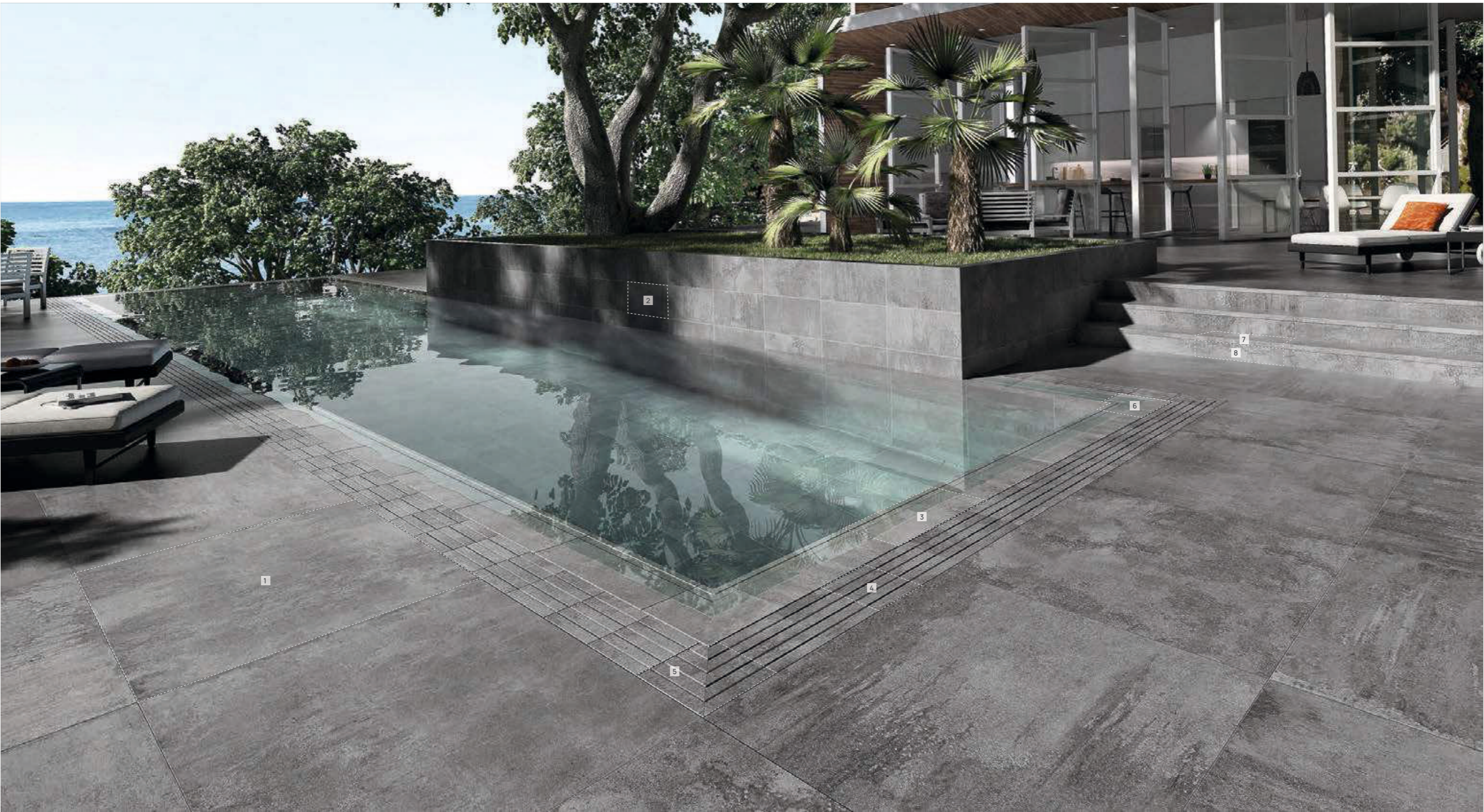

URBAN

Ópera outdoor+overflow pool coping



ivory] **1** Base · 120x120 cm - C-3 / R12+C
2 Base · 33x66,5 cm - C-3 / R12+C

3 Borde desbordante · 28x66,5 cm - C-3 / R12+C
4 Áng. desbordante · 31x31 cm - C-3 / R12+C

5 Rejilla · 24,5x24,5 cm - C-3 / R12+C
6 Áng. rejilla · 33x33 cm - C-3 / R12+C

iron] **1** Base · 120x120 cm - C-3 / R12+C
2 Base · 60x120 cm - C-1 / R9
3 Borde desbordante · 28x66,5 cm - C-3 / R12+C

4 Áng. desbordante · 31x31 cm - C-3 / R12+C
5 Rejilla · 24,5x24,5 cm - C-3 / R12+C
6 Áng. rejilla · 24,5x33 cm - C-3 / R12+C

7 Media caña 4 · 4,2x33 cm
8 Peld. recto 120 · 33x120x3 cm - C-3 / R12+C
8 Tabica · 14,5x120 cm - C-1 / R9



Borde desbordante
28 x 66,5 cm - 11.0" x 26.2"
C-3 R12 C



Ángulo desbordante
31 x 31 cm - 12.2" x 12.2"
C-3 R12 C



Rejilla
24,5 x 24,5 cm - 9.6" x 9.6"
C-3 R12 C

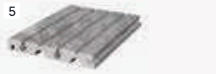

Áng. rejilla izda./dcha.
33 x 33 cm - 13.0" x 13.0"
C-3 R12 C



Media caña 4
4,2 x 33 cm - 1.7" x 13.0"



Peldaño recto 120
33 x 120 x 4 cm - 13.0" x 47.2" x 1.6"
C-3 R12 C



URBAN

Ópera in&out+skimmer pool coping



ivory]

1 Base · 60x120 cm - C-3 / R12+C

2 Peldaño recto 120 · 33x120x3 cm - C-3 / R12+C

3 Base · 60x120 cm - C-1 / R9

4 Peldaño recto 120 · 33x120x3 cm - C-1 / R9

5 Tabica · 14,5x120 cm - C-1 / R9



URBAN

Ópera in&out+skimmer pool coping

light]

- 1 Base · 60x120 cm - C-1 / R9
- 2 Base · 60x120 cm - C-3 / R12+C
- 3 Peldaño recto 120 · 33x120x3 cm - C-3 / R12+C

- 4 Borde skimmer · 45x75x3 cm - C-3 / R12+C
- 5 Tabica · 14,5x120 cm - C-1 / R9

Ópera in&out+infinity skimmer pool coping

silver]

- 1 Base · 60x120 cm - C-1 / R9
- 2 Base · 120x120 cm - C-3 / R12+C
- 3 Base · 60x120 cm - C-3 / R12+C

- 4 Borde skimmer · 45x75x3 cm - C-3 / R12+C
- 5 Media caña 4 · 4,2x33 cm
- 6 Uña media caña 4 · 4,2x4,2 cm



Borde skimmer
45 x 75 x 3 cm
17.7" x 29.5" x 1.2"

C-3 R12 C



Media caña 4
4,2 x 33 cm
1.7" x 13.0"



Uña media caña 4
4,2 x 4,2 cm
1.7" x 1.7"

